

Article number: 2301170927

Description: E+G Handwheel
VDT.200+IR A-20

Measures

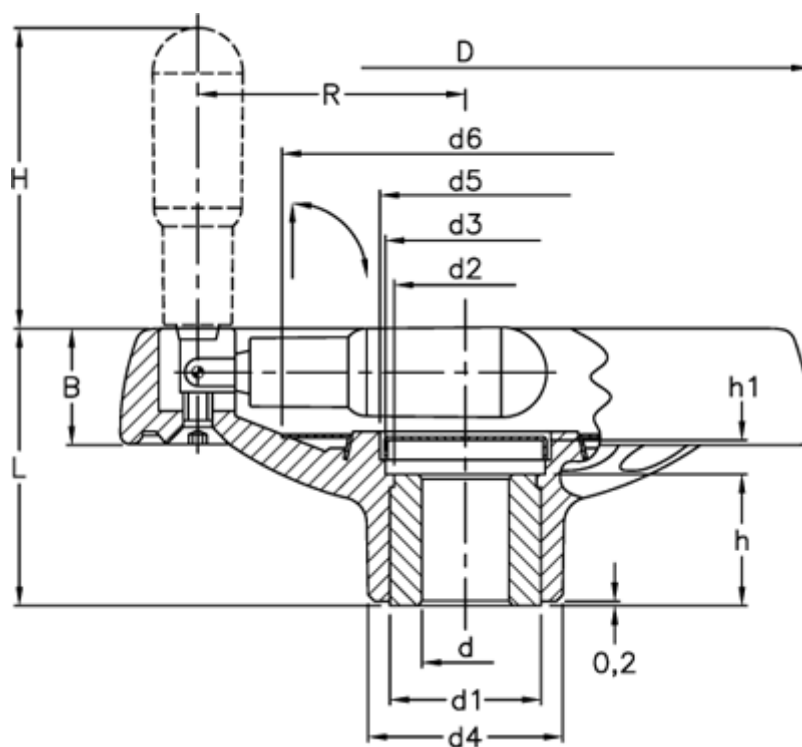

B	= 30	d6	= 110
C (N m)	= 600	d H7	= 20
D	= 200	H	= 90
d1	= 40	h	= 31
d2	= 36	h1	= 9.0
d3	= 50	L	= 68
d4	= 51	L (J)	= 35
d5	= 52	R	= 78